

NC 50

BATCH CHLORINATOR ELECTROLYZER

**BRINE
Electrolyzer**

DIMENSION SPECIFICATION

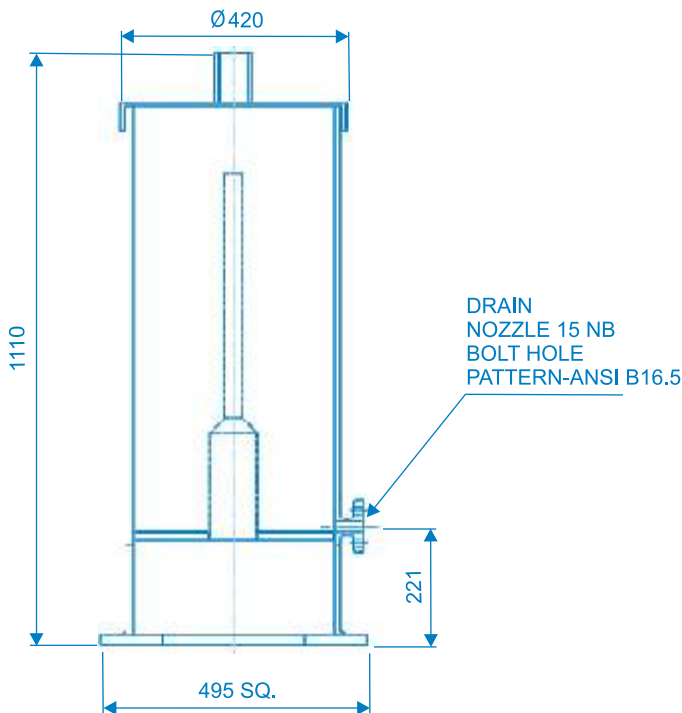

CONSTRUCTION SPECIFICATION

CAPACITY	MOUNTING TYPE	BODY	ANODE	CATHODE	SPACER
500 g/batch (8hrs / batch)	VERTICAL	PVC + FRVE	TITANIUM Gr.2 WITH PRECIOUS METAL OXIDE COATING	TITANIUM Gr.2 WITH PRECIOUS METAL OXIDE COATING	PTFE / PVDF