

KLOROGEN B150

PARALLEL PLATE ELECTROLYZER

**BRINE
Electrolyzer**

DIMENSION SPECIFICATION

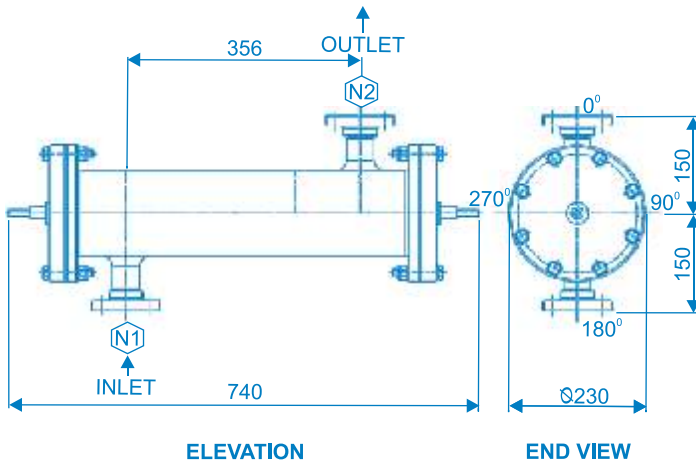

MARK	QTY	SERVICE	NB	RATING	BOLT HOLE PATTERN
N1	1	BRINE INLET	25	150#	ANSI B16.5 (OFF Crs.)
N2	1	HYPOCHLORITE OUTLET	25	150#	ANSI B16.5 (OFF Crs.)

All dimensions are in mm.

CONSTRUCTION SPECIFICATION

CAPACITY	MOUNTING TYPE	BODY	ANODE	CATHODE	SPACER
150 g/hr	HORIZONTAL	PVC + FRVE	TITANIUM Gr.2 WITH PRECIOUS METAL OXIDE COATING	TITANIUM Gr.2 WITH PRECIOUS METAL OXIDE COATING	PTFE

www.electrochlorinator.com

KLOROGEN[®]
Registered Trademark of Titanium Tantalum Products Limited.
sales@titanindia.com
www.titanindia.com

Titanium Tantalum Products Limited
86/1, Vengaivasal Main Road,
Gowrivakkam, Chennai 600 073, INDIA
☎ +91-44-22781210/0211/0212
☎ +91-44-22780209

TITAN[®]
SINCE 1981